



川源(中国)机械有限公司
GSD (China) Co., Ltd.



MA 潜水搅拌机

MA submersible mixer

MA 潜水搅拌机

MA submersible mixer



混合搅拌器(带导流罩)
Mixing agitator (With dome)



混合搅拌器
Mixing agitator

用途 Application

潜水搅拌机主要运用在市政和工业污水处理过程中的混合、搅拌和环流，也可用作景观水环境的养护设备，通过搅拌达到创建水流作用，改善水体质量，增加水中含氧量，有效阻止悬浮物沉积。

The submersible mixers are mainly used for the purposes of mixing, agitating and making ring flows in the process of municipal and industrial sewage treatment and can also be used as the maintenance equipment for the landscape water environment; through agitation, they can achieve the function of creating water flow, improving the quality of the water body, increasing the oxygen content in water and effectively preventing the sedimentation of the suspended substances.

特点 Features

- 两道独立的机械密封，保证潜水电机长期可靠运行。
 - 高质量国际知名品牌免维护轴承，使用寿命长。
 - 独特的电缆密封设计，排除了电缆漏水的隐患。
 - 电机轴采用不锈钢材质，转子经动平衡检测，运转平稳。
 - 内部设有泄漏传感器和定子绕组超温保护装置 (MA0.37/6、MA0.55/4无泄漏传感器)。
 - 混合搅拌器的不锈钢冲压叶桨，经优化设计叶片呈后掠式，效率高，具有自清洁功能。
- The two rows of independent mechanical sealing ensure the long-term and reliable operation of the submersible motor.
 - The international well-known high-quality bearings have longer service life, which are maintenance free.
 - The unique sealing design for the cables removes the hidden danger of water leakage for the cables.
 - The shaft of the motor employs the stainless steel, and the rotors are inspected with the use of dynamic balancing, leading to smooth rotation.
 - The in-built leakage sensor and the device for the overtemperature protection for the windings of the stator(No leakage sensor for MA0.37/6 or MA0.55/4).
 - The mixer agitators have the stainless steel pressing impeller, which are of the sweptback shape through the optimized design, resulted in high efficiency and self-cleaning function.

适用条件

- 介质温度：≤40°C
- 介质pH值：5~9
- 介质密度：≤1150kg/m³
- 潜水深度：≤20m
- 电源：380V，50Hz
- 电机：F/H级绝缘并符合IP68，24小时连续运行
- 潜水搅拌机必须完全潜入水中工作

Conditions of usage

- The highest temperature of the media shall not exceed 40°C
- The pH value of the media: 5~9
- The density of the media shall not exceed 1150kg/m³
- The depth of submersion shall not exceed 20m
- The electric power supply: 380V, 50Hz
- The motor: F/H class insulation and in accordance with IP68, continuous operating in 24hr
- The submersible mixer must operate in the complete submersion into water

结构简图 Construction

不同功率结构略有不同

The structure will be different according to the power.

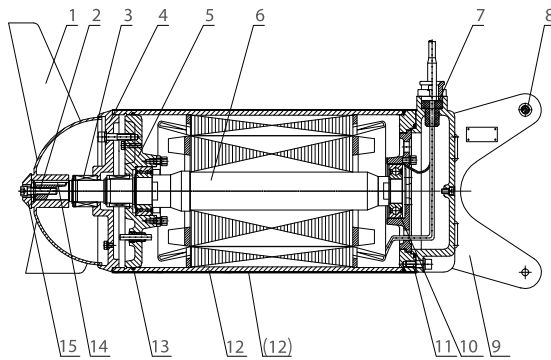

NO.	名称	Name	材质	
			GB	JIS
1	叶桨	Propeller	06Cr19Ni10	SUS304
2	锁紧螺钉	Lock nut	06Cr19Ni10	SUS304
3	机械密封	Mechanical seal	SiC-SiC	SiC-SiC
4	机封座	Mechanical seal stand	ZG07Cr19Ni10	SUS304
5	前轴承座	Front bearing support	HT200	FC200
6	主轴	Main shaft	06Cr19Ni10	SUS304
7	水密头	Watertight head	硫化橡胶	VR
8	滚轮	Roller	ZG07Cr19Ni10	SUS304
9	接线盒	Junction box	ZG07Cr19Ni10	SUS304
10	轴承	Bearing	-	-
11	内六角螺钉	Inner hexagonal screw	06Cr19Ni10	SUS304
12	机壳	Shell	Q235	Q235
(12)	外包层	Sheath	06Cr19Ni10	SUS304
13	O型橡胶密封圈	O-type sealant ring	丁腈-70/NBR-70	NBR-70
14	平键	Flat key	45	S45C
15	叶轮压紧圈	Wheel clamp ring	06Cr19Ni10	SUS304

上表为MA标配材质，其它材质请另询！

The table above is standard material for MA type. If other material needed, pls contact us.

型号说明 Type description

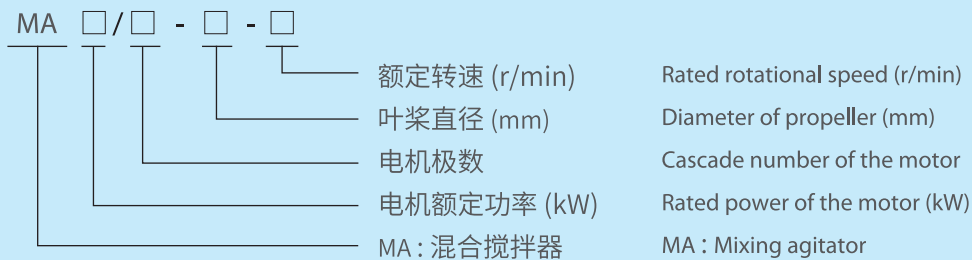

性能参数 Performance parameters

泵型号 Pump model	电机功率 Motor power (kW)	额定电流 Rated current (A)	叶浆转速 rpm of propeller (r/min)	叶浆直径 Diameter of propeller (mm)	推力 Thrust (N)	重量 Weight (kg)
MA0.37/6-220-960	0.37	1.3	960	220	138	24
MA0.55/4-220-1400	0.55	1.6	1400	220	145	24
MA0.85/8-260-740	0.85	3.2	740	260	163	44
MA1.5/6-260-960	1.5	4	960	260	290	44
MA2.2/8-320-740	2.2	5.9	740	320	582	76
MA4/6-320-960	4	10.3	960	320	609	90
MA1.5/8-400-740	1.5	5.2	740	400	600	69
MA2.5/8-400-740	2.5	7	740	400	800	78
MA3/8-400-740	3	8.6	740	400	920	87
MA4/6-400-960	4	10.3	960	400	1200	92
MA4/12-620-480	4	14	480	620	1400	188
MA5/12-620-480	5	18.2	480	620	1800	197
MA7.5/12-620-480	7.5	28	480	620	2600	239
MA10/12-620-480	10	32	480	620	3300	256
MA15/12-620-480	15	39	480	620	4000	276

注：1、上表“重量”一栏分别表示不带导流罩和含导流罩的重量。

In the above table, the value listed in the column of "weight" respectively contains the weight of without or with the dome.

2、叶浆直径220mm的混合搅拌器叶浆为二叶片式,其余均为三叶片式。

Mixer agitator whose propeller diameter is 220mm has two vanes, other has three vanes.

流场图 Diagrams of the flow field

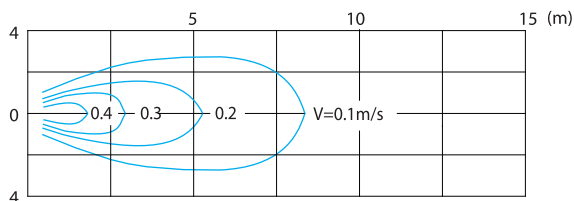

MA0.37/6-220-960

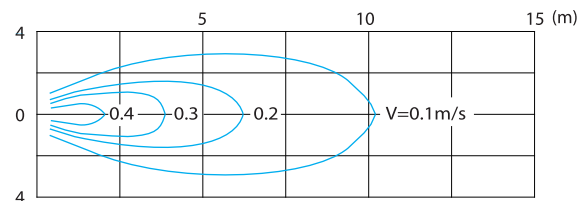

MA0.55/4-220-1400

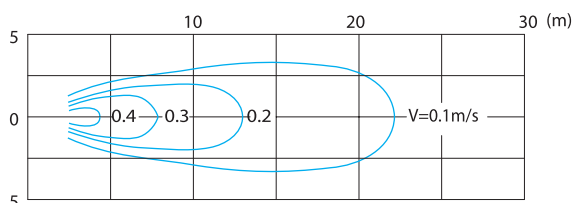

MA0.85/8-260-740

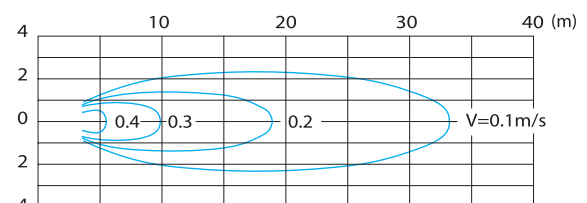

MA1.5/6-260-960



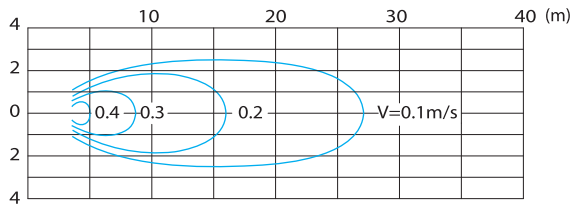

MA1.5/8-400-740

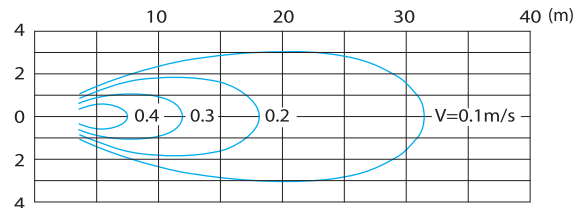

MA2.2/8-320-740

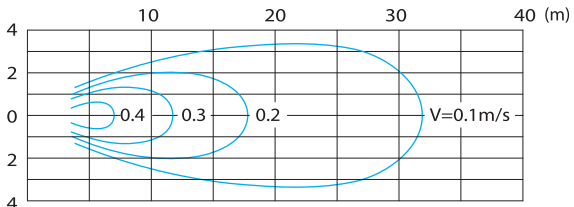

MA2.5/8-400-740

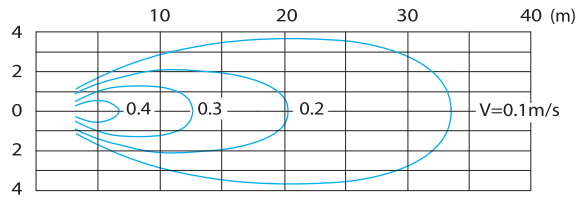

MA3/8-400-740

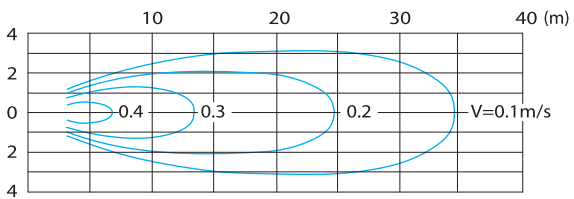

MA4/6-320-960

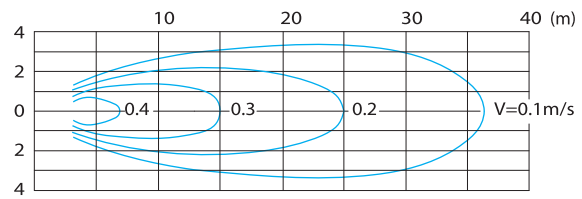

MA4/6-400-960

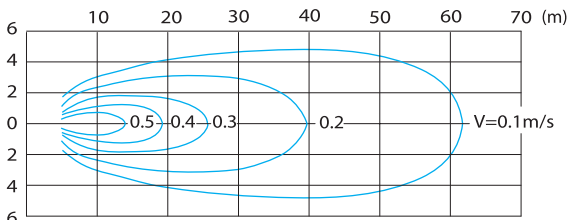

MA4/12-620-480

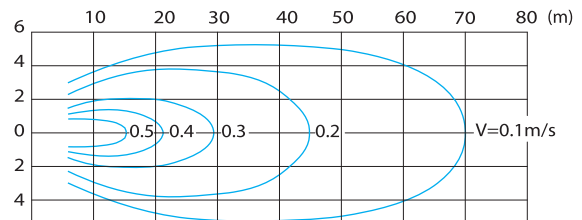

MA5/12-620-480

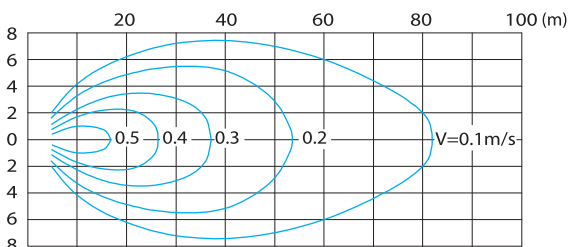

MA7.5/12-620-480

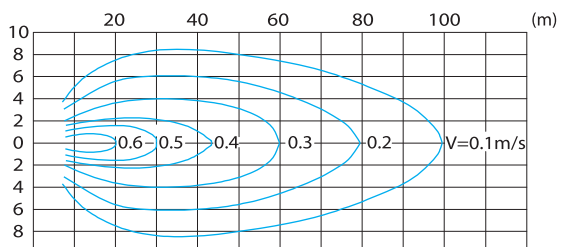

MA10/12-620-480

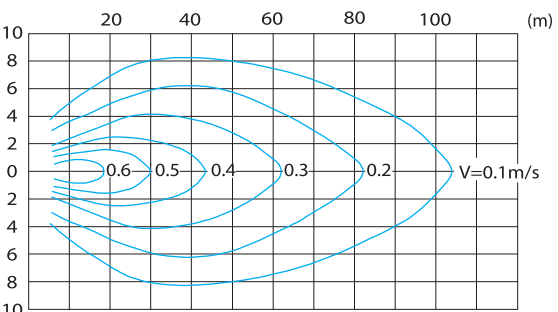

MA15/12-620-480

安装方式及尺寸

潜水搅拌机可以有多种安装方式, 这里提供最通用的方式供选择, 尺寸可参考下表。我公司还可以根据用户的要求作特殊设计。

Installation modes and dimensions

The submersible mixers can be installed in a multiple of modes. Here are generally accepted modes of installation for selection with reference made to the following table. Our company can also provide the special designs in accordance with the demand of the users.

型号 Type	D	L	H _{1min}	H _{2min}	安装系统 Installation system
MA0.37/6-220-960	340	650/700	500/800	110/150	I/II
MA0.55/4-220-1400	340	650/700	500/800	110/150	I/II
MA0.85/8-260-740	360	750/800	500/800	110/150	I/II
MA1.5/6-260-960	360	750/800	500/800	110/150	I/II
MA2.2/8-320-740	460	950	800	150	II
MA4/6-320-960	460	1100	800	150	II
MA1.5/8-400-740	500	950	800	200	II
MA2.5/8-400-740	500	950	800	200	II
MA3/8-400-740	500	1100	800	200	II
MA4/6-400-960	500	1100	800	300	II
MA4/12-620-480	760	1250	1100	300	III
MA5/12-620-480	760	1250	1100	300	III
MA7.5/12-620-480	760	1350	1500	300	III
MA10/12-620-480	760	1350	1500	300	III
MA15/12-620-480	760	1350	1500	300	III

注:

- 潜水搅拌机的专用安装系统, 可在无需排出池中污水的情况下, 快速安装和拆卸潜水搅拌机。
- 安装系统 I 只适用于机型为 MA0.37/6, MA0.55/4, MA0.85/8, MA1.5/6, 可在水平方向和垂直方向调节角度。
- 安装系统 II、III 导杆可沿水平方向绕导杆轴线旋转, 最大转角为 $\pm 60^\circ$ 。
- 当 $H > 6m$ 时需在导杆中间添加一支撑架。
- 支撑架和下托架与池壁、池底均可用膨胀螺栓或化学锚栓固定, 对于大直径叶轮和大功率搅拌机最好采用预埋。
- 客户定货时, 请提供池深 H 及池型图, 以便确定导杆尺寸和支撑架个数。
- 同一种安装系统, 多台搅拌机可共用一套起吊系统。
- 安装系统材质选择采用不锈钢和碳钢防腐可供选择。

Notes:

- The special installation systems for the submersible mixers can facilitate the quick installation and dismantling of the submersible mixers under the conditions of no need for draining off sewage from the pond.
- Installation System I is only suitable for the mixer models of MA0.37/6, MA0.55/4, MA0.85/8 and MA1.5/6 and with the possibility of adjusting the angles in both the horizontal and longitudinal directions.
- For installation systems II and III, the guide rod can rotate round the axial line of the guide rod along the horizontal direction with the maximum angle of rotation $\pm 60^\circ$.
- If $H > 6m$, it is necessary to add a supporting frame between the guide rods.
- The supporting frame and the lower support shall be fixed onto the pond wall and the pond bottom with the use of expansion bolts or chemical anchors. For the big diameter impellers and the big power mixers the best choice is to pre-embed.
- While placing an order by customer. Please supply the pond depth H and the drawing of the pond shape so as to determine the dimensions of the guide rod and the number of the supporting frames.
- A multiple of mixers with the same installation system can share one lifting system.
- The installation systems may employ the material of stainless steel or carbon steel for the selection of the corrosion-resisting properties.



外形及安装尺寸 Installation dimensions

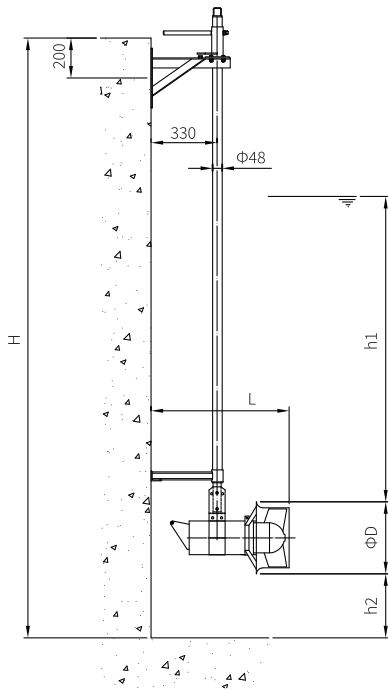

I 型安装

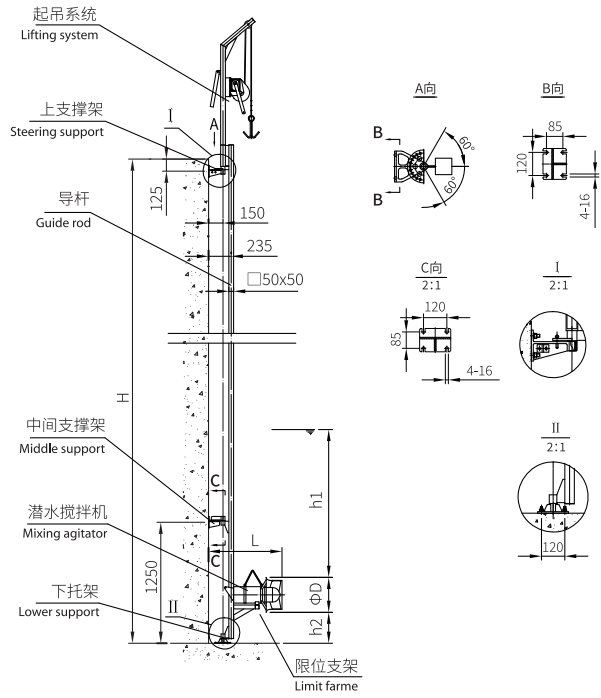

II 型安装(50导杆)

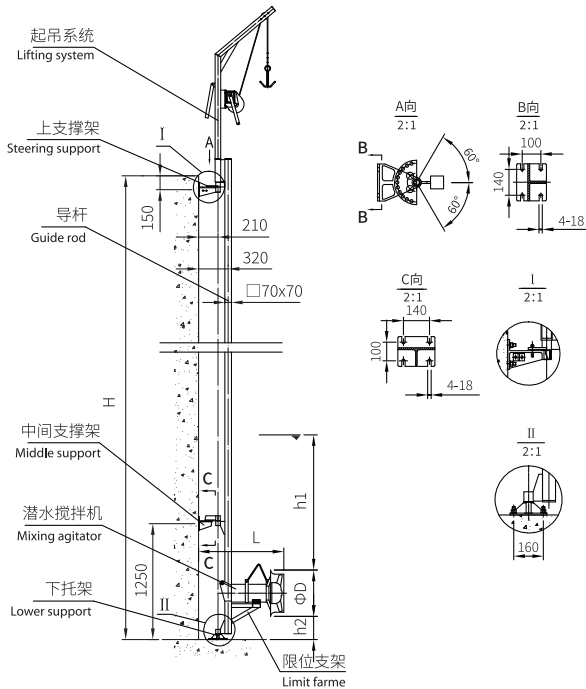

II 型安装(70导杆)

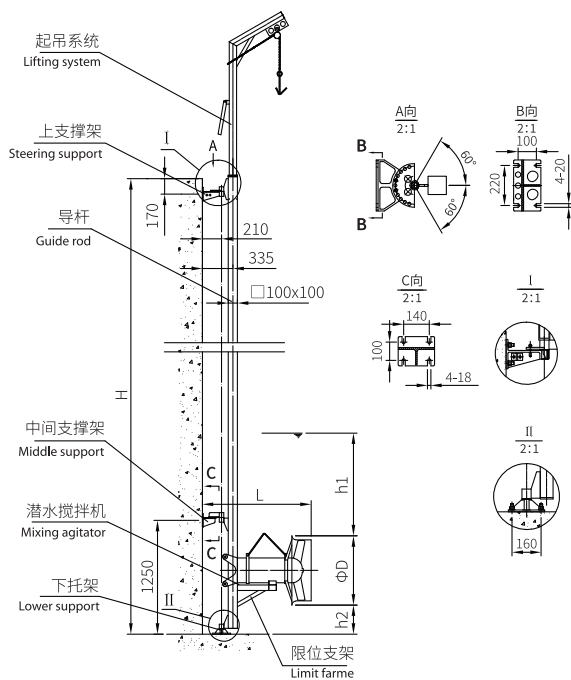

III型安装(100导杆 葫芦式)

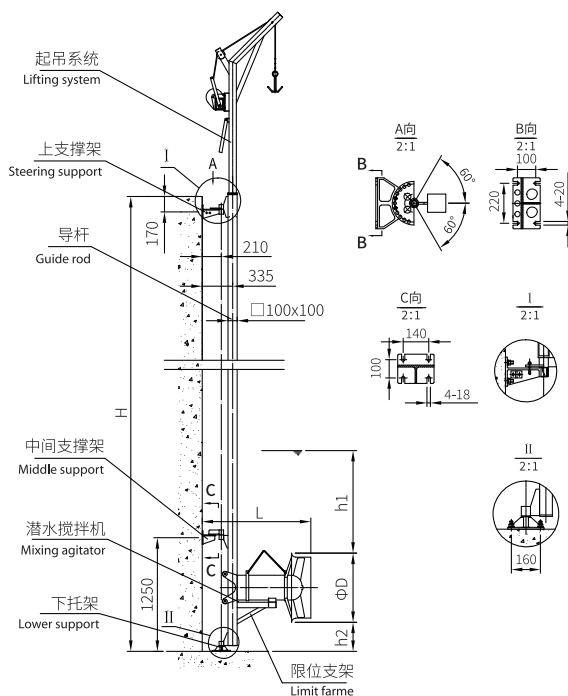

III型安装(100导杆 绞盘式)



配置示意图

潜水搅拌机的安装定位对其搅拌效果有很大的影响, 为了达到良好的运行效果, 我们建议用户按照专业设计人员的要求去做, 要充分考虑到水池的形状, 进出水的位置以及搅拌机的水流反射到构筑物而引起的涡流等情况, 尽量减少短路循环和死角的生产, 避免与池壁的撞击而降低流速。参照下面的配置示意图, 可帮助您合理选择搅拌机和安装型式。

Arranging sketch map

The installation and positioning of the submersible mixers will produce a great impact on the effect of mixing. In order to obtain the perfect operating result, it is suggested that the advice of the specialized designers shall be followed and full consideration given to the shape of the pond, position of the water inlet and outlet, the vortex resulting from the outflow from the mixer onto the structures and some other conditions. Every effort shall be made to reduce the short-circuit circulation and the occurrence of dead corners and avoid the dashing of the flow against the pond wall for lowering the flow velocity. Making reference to the arranging sketch map below will help you to make a reasonable selection of the mixers and their installation modes.

混合搅拌器 Mixing agitator

避免短路循环
Avoid short circuit flows

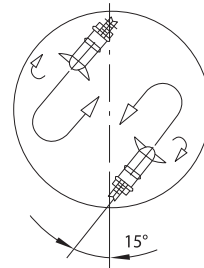
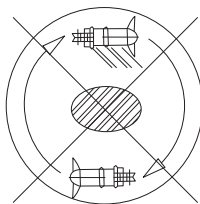

考虑进出口
Take inlet and outlet into account

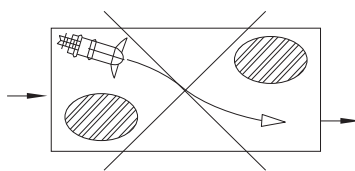

考虑喷射流范围, 避免与池壁发生不必要的冲撞
Take jet expansion into account, no unnecessary wall friction.

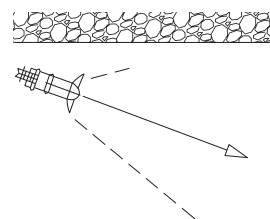
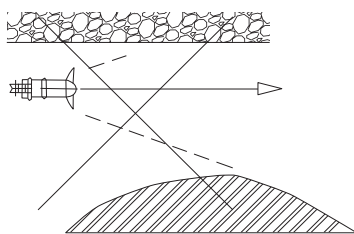

安装引起的死区

Installations cause dead zones

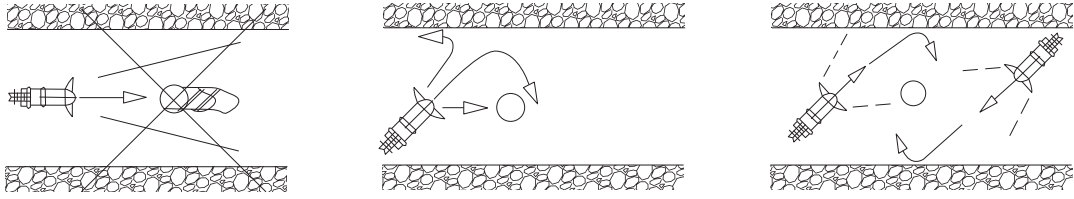

喷射流的交叉

Jet intersections

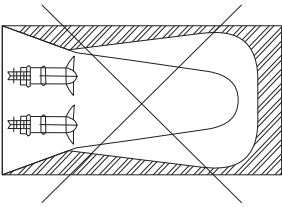

考虑到恒一能量的供应

Take uniform energy supply into account

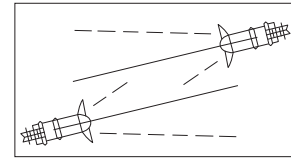

利用池壁反射

Use wall reflections

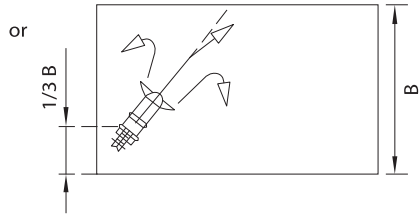
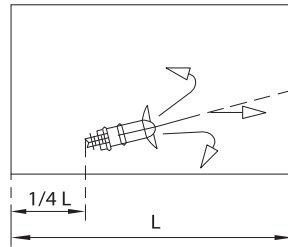
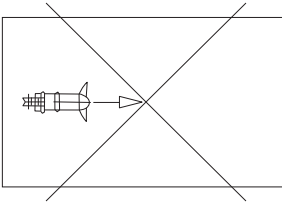







如蒙洽询请指示下列各项

For further details, please fulfill the chart below.

客户 _____ 承办人员 _____
Customer _____ Undertaker _____

工程名称 _____ 工程地点 _____
Name of project _____ Address of project _____

电话 _____ 传真 _____
Telephone _____ Fax _____

基本选型参数 Basic parameters	*工艺名称 Processes name	氧化沟 Oxidation ditch	<input type="checkbox"/>	A-O法 A-O	<input type="checkbox"/>	SBR法 SBR	<input type="checkbox"/>	其它(注) Others			
	*安装位置 Installation location										其它(注) Others
	*基本池型(m) Pond form	长 L	宽 W	深 H	长 L	宽 W	深 H	长 L	宽 W	深 H	
	*有效水深(m) Available water depth										
介质参数 Media parameter	介质名称 Name						密度 Density				
	主要成分 Main composition						* PH值 PH				
	* 温度 Temperature						黏度 Viscosity				
	其它 Other										
工艺要求参数 Technique parameters	*主要搅拌混合方式 Mixing methods			搅拌型 Mixing agitator		<input type="checkbox"/>	推流型 Flow propeller		<input type="checkbox"/>	其它(注) Other	
	*池底最低流速(m/s) Minimum flow speed at the bottom										
	其它工艺要求 Other requests										
池形结构 Pool structure	*池沿结构 Pool surface structure				<input type="checkbox"/>		<input type="checkbox"/>		<input type="checkbox"/>	其它 Others	<input type="checkbox"/>
	*池底结构 Pool bottom structure				<input type="checkbox"/>		<input type="checkbox"/>		<input type="checkbox"/>	其它 Others	<input type="checkbox"/>
材质要求 Material requests	主机壳体 Shell body						* 水下导杆及支座 Guide and support				
	搅拌叶桨 Mixing propeller						* 水上吊架及支座 Hanger and support				
	导流罩(是否需要) Fairwater(need or not)						* 螺栓、螺母及垫圈 Bolt, nut and gasket				
	主轴 Main shaft						* 提升钢丝绳 Boom hoist cable				
搅拌机结构性能参数 The machine parameters	传动方式 Driving method						电机功率(kW) Motor power				
	密封形式 Seal type						额定电流(A) Rated current				
	叶轮直径(mm) Propeller diameter						电源 Power				
	叶轮转速(rpm) Propeller speed						防护等级 Protection grade				
	推力(N) Thrust						工作制式 Working standard				
其它要求 Others											

注: 为准确选型, 项目前加注“*”号者, 请务必详加填写。

Note: In order to choose the right type, the item with “*” should be filled as detail as possible.



欢迎索取以下产品型录



泵系列

潜水泵系列 | 陆上泵系列 | 特种泵系列



搅拌推流系列

搅拌机系列 | 推流器系列



供氧曝气系列

曝气机系列 | 曝气盘系列 | 曝气管系列



风机系列

磁悬浮鼓风机 | 空气悬浮鼓风机 | 三叶罗茨鼓风机系列



污泥处理设备

带式脱水机 | 厢式压滤机 | 叠螺式脱水机 | 污泥干化设备 | 浅层高效气浮设备



智能化系列

智能设备 | 水务设备健康管理 | 水务系统工艺优化智联管理



反应器及套装设备

芬顿反应系统 | MBR生物膜反应器 | 预制泵站 | 一体化污水处理设备



耗材药剂及相关设备

生物绳 | PAC 聚合氯化铝 | PAM 聚丙烯酰胺 | 泡药设备

GSD 的经营理念

G-Green 绿色 **S-Safe 安全** **D-Development 永续经营**



川源

水处理系统专业合作伙伴

免费咨询电话

400-657-9066

数据来源：公司实验室数据及客户实际使用数据，具体使用环境不同，数据可能存在差异。

The data on the brochure is based on the laboratory testing data and customers' actual operation data in the past. The actual data may be different in different application conditions.

本型录内容如有变更，恕不另行通知。

We reserve the right to change content without notice.

川源(中国)机械有限公司版权所有 all rights reserved. CY-31

